









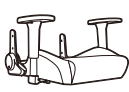
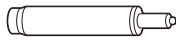

Nitro
S300 GAMING CHAIR

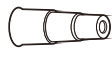
| | | | |
|----------|---|----------|---|
| A |  x 5 | F |  |
| B |  | G |  |
| C |  | H |  x 2 |
| D |  | I |  x 2 |
| E |  | J | Washer Spring Washer x 4 |
| | | K |  |

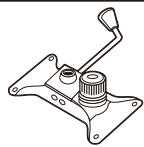

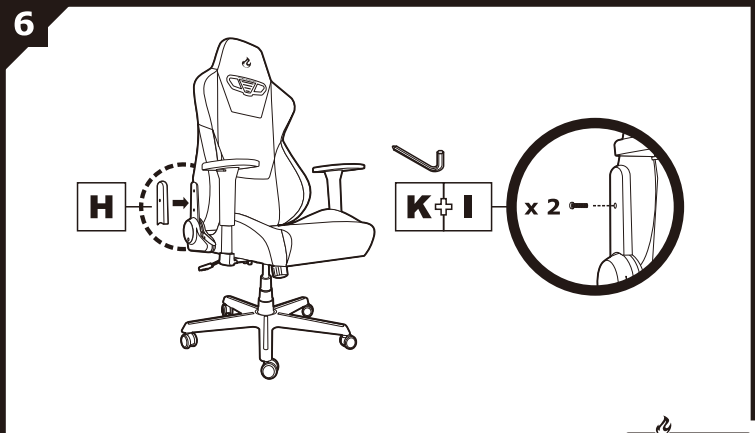
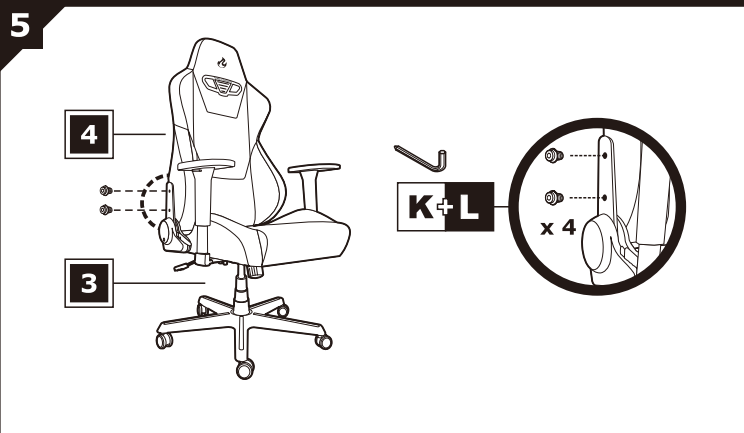
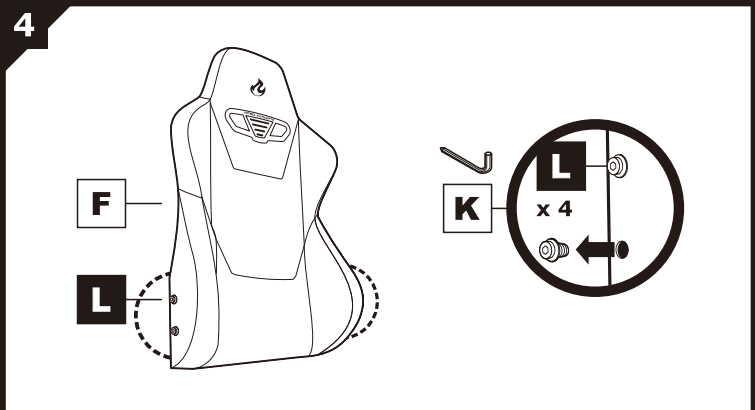
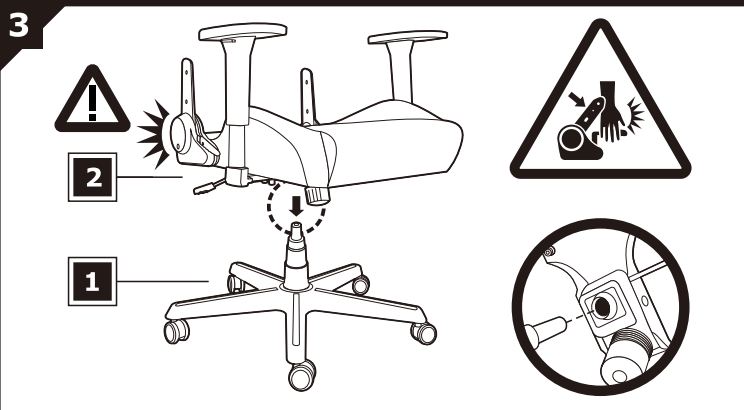
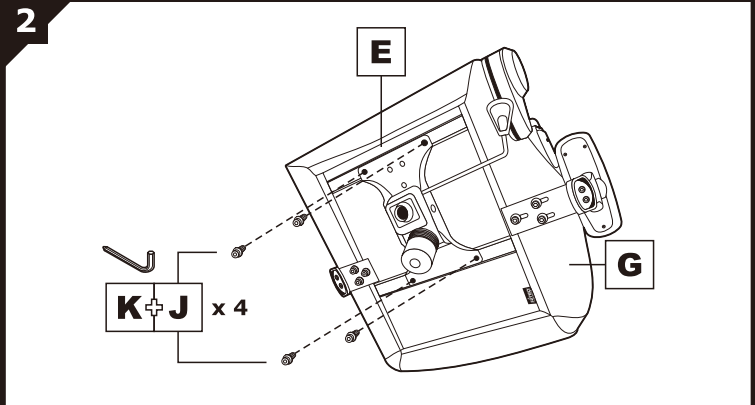
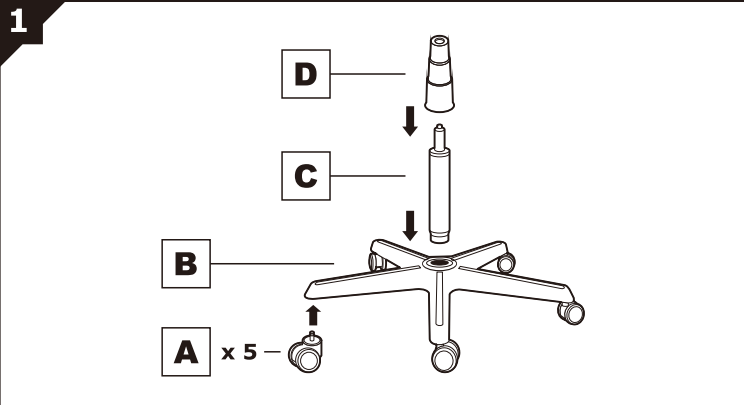
Usage Information / Nutzungsinformationen / Gebruiks informatie

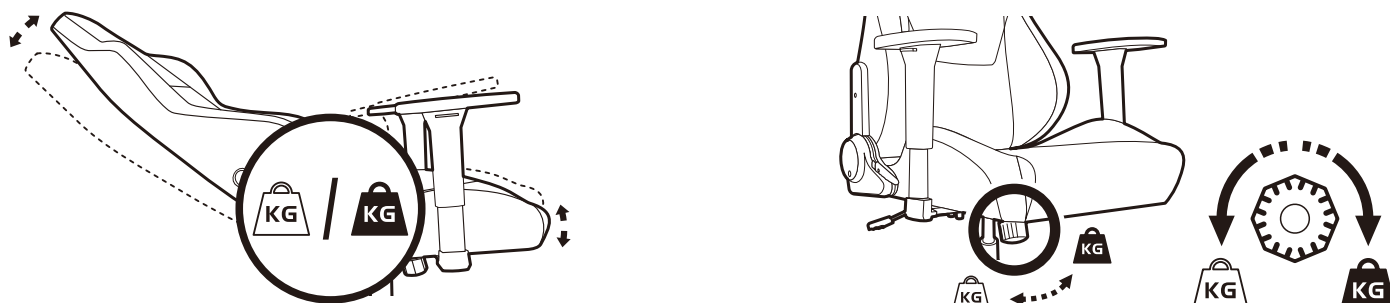
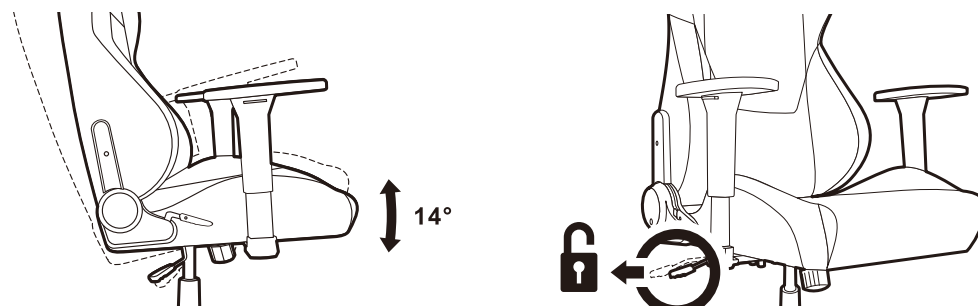
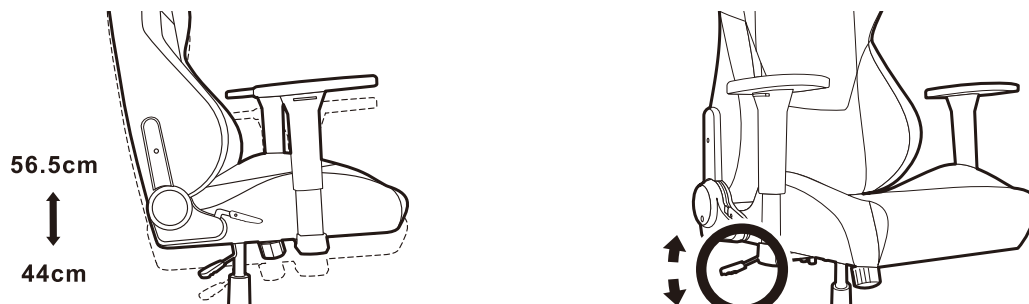
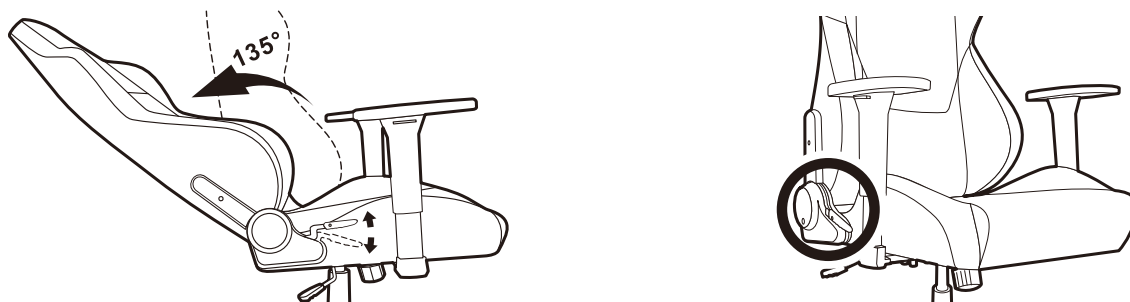
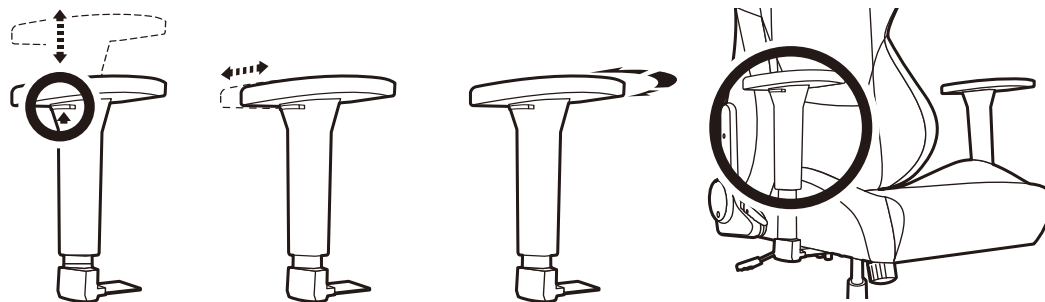

 info@nitro-concepts.com

 www.nitro-concepts.com