

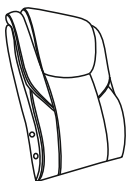





ИНСТРУКЦИЯ ЗА МОНТАЖ НА ПРЕЗИДЕНТСКИ СТОЛ CARMEN 5025

<p>①×1</p> 	<p>②×1</p> 	<p>③×2</p> 	<p>④×1</p> 	<p>⑤×1</p> 
<p>⑥×5</p> 	<p>⑦×1</p> 	<p>⑧×1</p> 	<p>⑨×2</p>  <p>M8×25</p>	<p>⑩×2</p>  <p>M8×41</p>
<p>⑪×12</p>  <p>1/4 × 1-1/4"</p>	<p>⑫×8</p> 	<p>⑬×1</p> 	<p>Вносител: "Биттел" ЕООД гр. Пловдив, Тракия ул. "Нестор Абаджиев" 13 БУЛСТАТ: 115163890 Тел: +359 32 27 00 27 www.bittel.bg</p>	

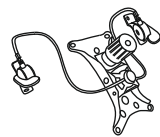
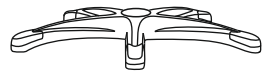
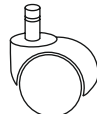
STEP1

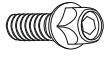
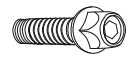
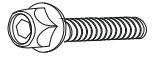

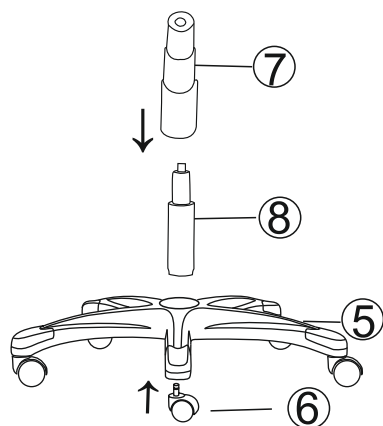
STEP2

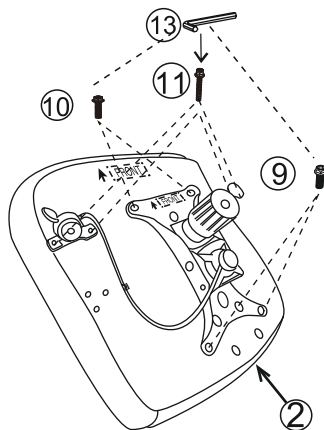

STEP3

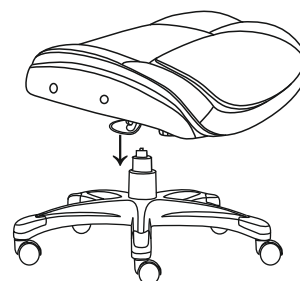

STEP4

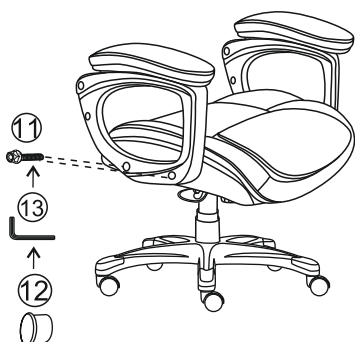

STEP5

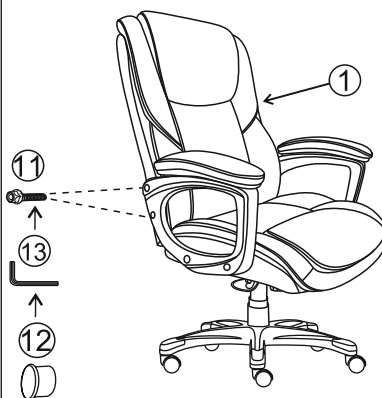

STEP6



Максимално натоварване: 130 кг.