

Инструкция за монтаж на бар стол MERTON

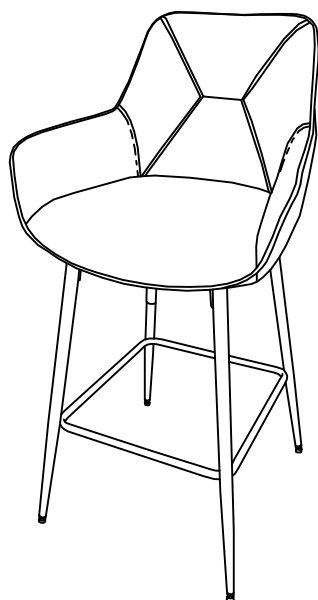

A		1	G		2
B		1	H		4
C		4	I		1
D		2	J		1
E		8	K		1
F		4			

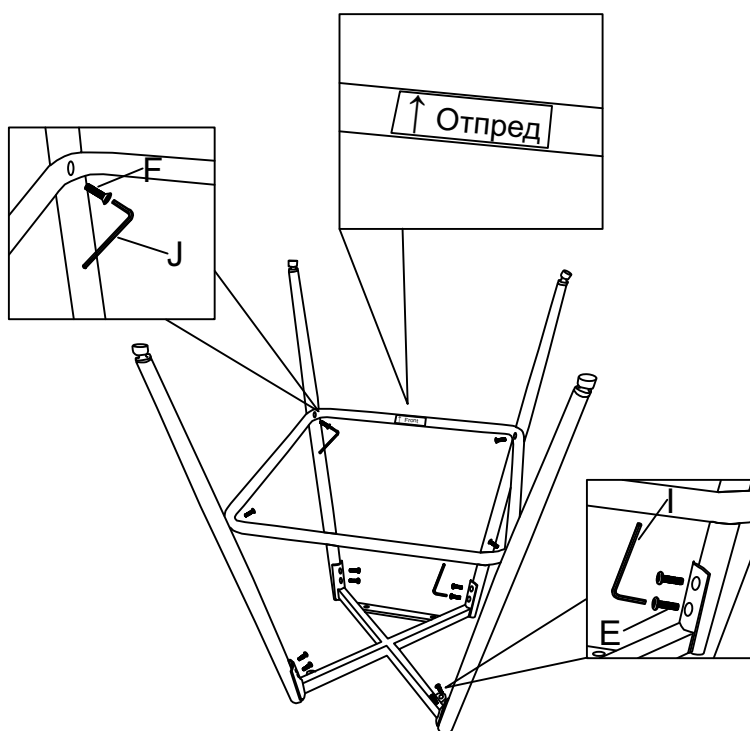
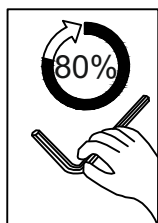

Инструкция за монтаж на бар стол MERTON

2

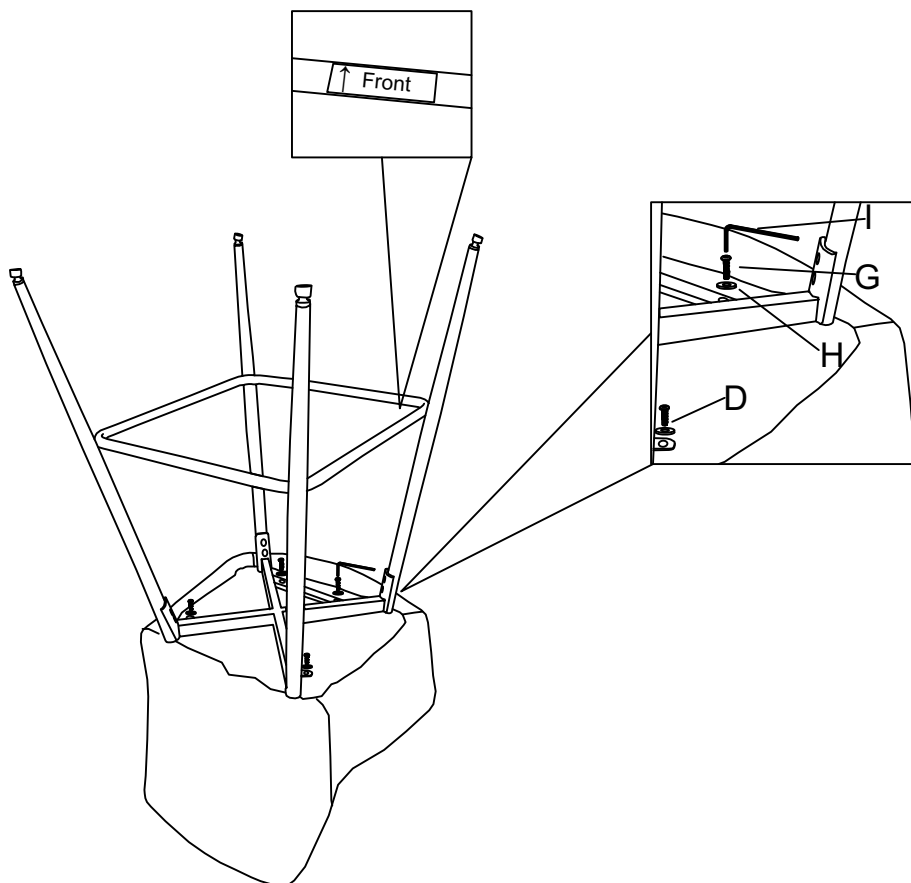
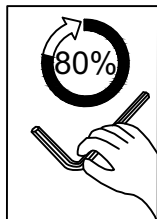

3

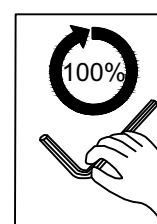
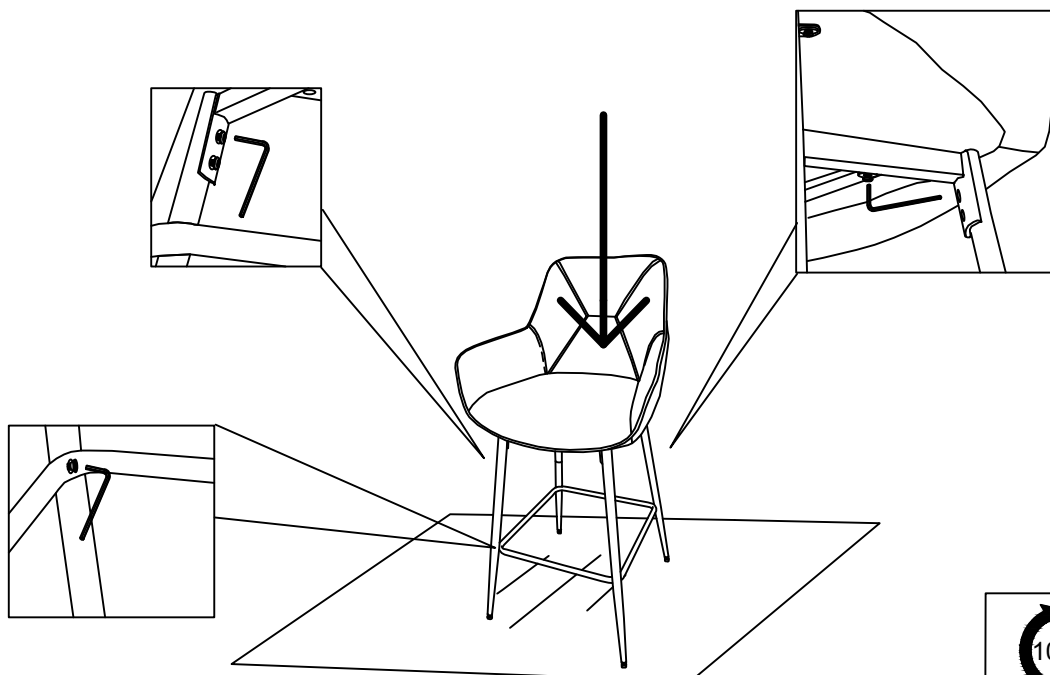

Максимално натоварване: 100 кг