

Вносител: "Биттел" ЕООД
 гр. Пловдив, Тракия
 ул. "Нестор Абаджиев" 13
 БУЛСТАТ: 115163890
 Тел: +359 32 27 00 27
www.bittel.bg

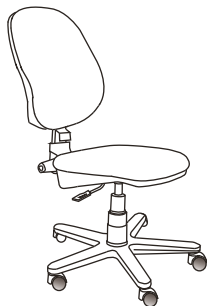

Importer: BITTEL LTD
 Plovdiv, Trakia Ind. zone,
 13 Nestor Badjiev str.
 ID:115163890
 Tel: +359 32 27 00 27
www.bittel.bg

ASSEMBLING INSTRUCTION : ACTIVE
ИНСТРУКЦИЯ ЗА МОНТАЖ : ACTIVE

Assembling parts / Елементи :

- | | |
|----------------------|----------------------|
| A- Castors | A- Колелца |
| B- Base | B- База |
| C- Gas lift | C- Газов амортисъор |
| D- Ring | D- Пръстен |
| E- Gas lift cover | E- ПВХ маншон |
| F- Permanent contact | F- Перманент контакт |
| G- Cover | G- Кожух |
| H- Seat | H- Седалка |
| I- Back | I- Облегалка |
| J- Screw M8x35 | J- Винт M8x35 |
| K- Screw M8x18 | K- Винт M8x18 |

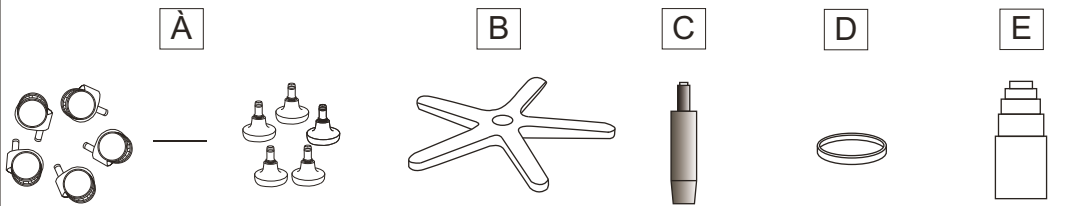
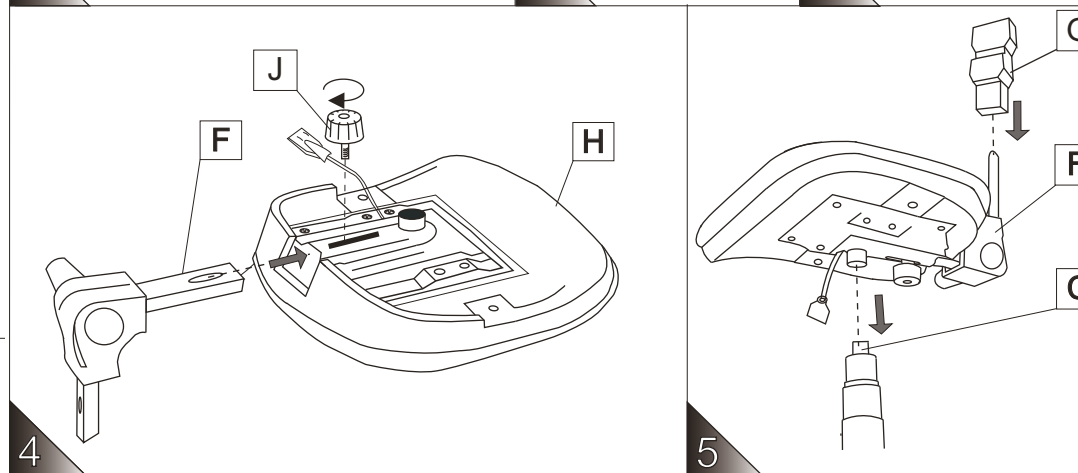
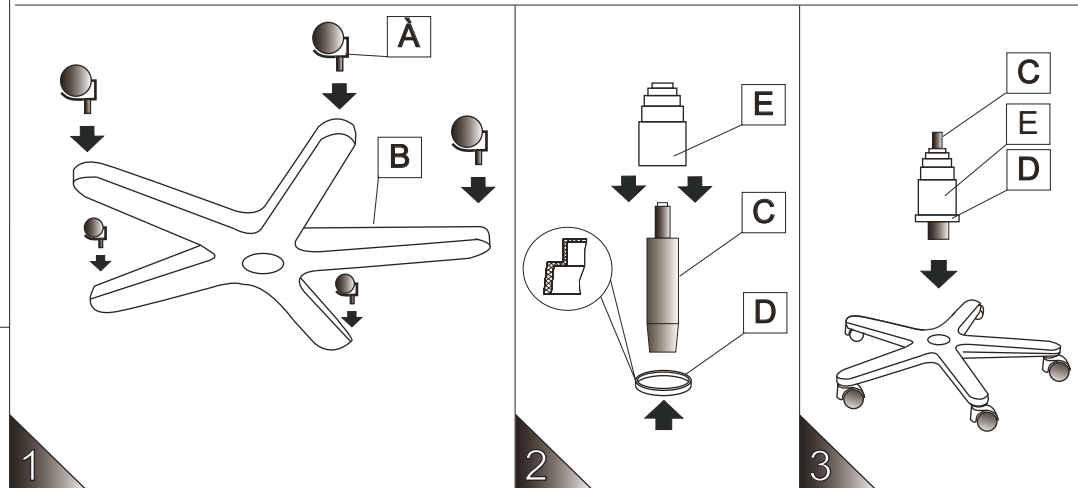
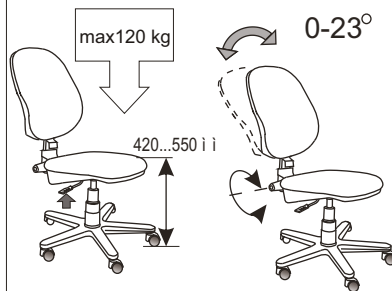

5 бр. 1 бр. 1 бр. 1 бр. 1 бр.

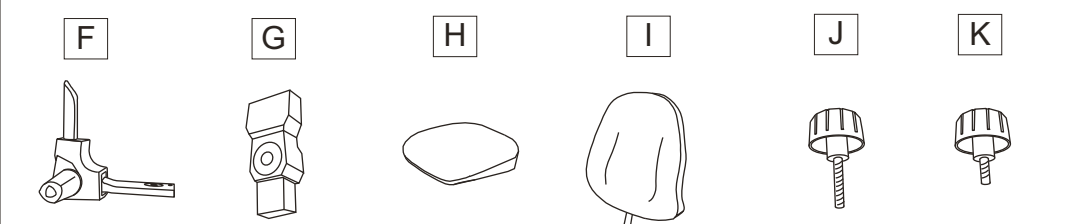

1 бр. 1 бр. 1 бр. 1 бр. 1 бр. 1 бр.

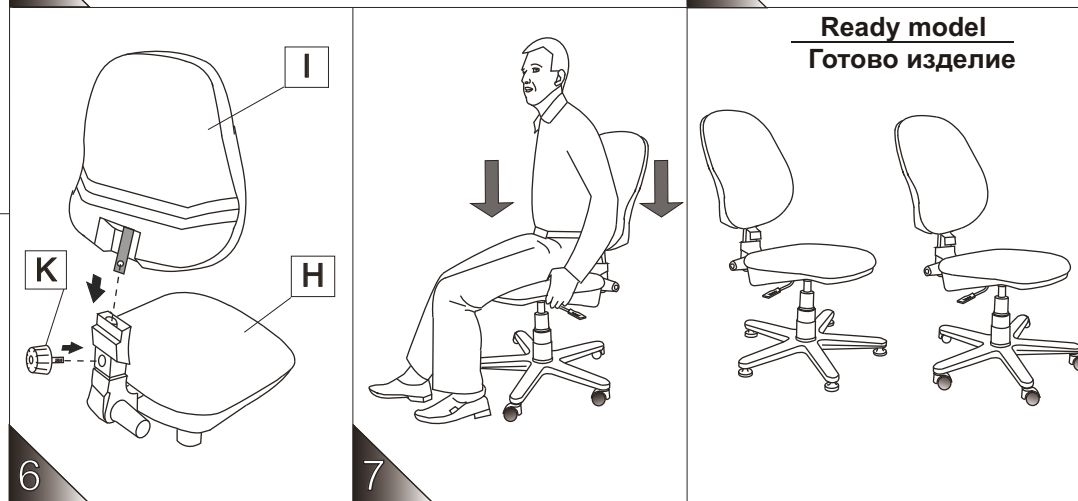

Ready model
Готово изделие